

# Canon



## Zoemini 2

Mini Photo Printer  
User Manual

# CONTENT

## **SAFETY INFORMATION**

Read Before Use ..... P.2-4

## **OVERVIEW**

Supplied Items ..... P.5

Product Features ..... P.5

## **GETTING STARTED**

Charging ..... P.6

Power ON/OFF ..... P.7

Load Paper ..... P.7-8

**LED INDICATOR** ..... P.9

**SPECIFICATIONS** ..... P.10

**INSTALLING THE APP** ..... P.11-12

## **PAIRING A MOBILE DEVICE & MINI PHOTO PRINTER**

Android and iOS Pairing ..... P.13-14

## **USER INTERFACE**

Home Screen ..... P.15

Main Menu ..... P.15

Printer Settings ..... P.16-17

# SAFETY INFORMATION

## READ BEFORE USE

Please read the following instructions and safety precautions before using the printer.

For regulatory and additional safety information, refer to the Regulation and Warranty Information sheet included in your package contents.

### **RMN: PP1003A**

Regulatory Model Identification Number is assigned for regulatory identification purpose.



### **WARNING**

Used to indicate a potentially hazardous situation which, if not avoided, could result in death or serious injury.

- Keep away from children and infants. Improper use of this product may cause suffocation or accident.
- Stop using the device immediately if it emits smoke or a strange smell, or otherwise behaves abnormally.
- Do not use the printer if the battery or product has swelled.
- Do not handle near Medical Electrical Equipment. Weak magnetism is emitted by this product. Do not stand near implanted electronic devices, such as a cardiac pacemaker. Please see your doctor if the printer does come close to such a device.



## **CAUTION**

Used to indicate the level of a hazard or damage which, if product is handled erroneously, may result in injury or property damage other than product faults.

- When operating in extreme weather, the device might not print. Let the printer temperature adjust to the recommended operating temperature of 15° to 32°C, before attempting to print again.
- When charging, please charge the device at the recommended temperature of 15° to 32°C.
- Use a soft dry cloth to clean the device. Do not clean with a damp cloth or volatile liquids such as paint thinner.
- Keep the top cover closed to avoid dust and other particles from entering the inside of the device.
- Keep the ventilation openings clear of any objects that could block them.
- If the device is not functioning properly, please contact the dealer you purchased this product from or Canon Service & Support at [www.canon-europe.com/support](http://www.canon-europe.com/support)
- Electromagnetic interference or electrostatic discharge may cause the device to malfunction or the memory to be lost or altered. Should this occur, use a pin, or similar item to press the [RESET] button at the bottom of the device.
- Do not use or leave the product under direct sunlight. Also avoid areas subject to rapid temperature changes, high humidity, dust and dirt.
- In areas with low humidity, the printer may build up a static electric charge. Take precautions before handling the printer.
- Keep the printer away from liquids or containers of liquids.
- Do not improperly dispose of the product as it may cause personal injury or harm. Please dispose of the product in accordance with local regulations.

## **ABOUT THE BATTERY**

- It is recommended that you fully charge the battery after use. For healthy battery maintenance, it is recommended that you fully charge the battery once a year before leaving it unused. If you keep the device under low-battery conditions for longer than six (6) months, you may not be able to charge the built-in battery.
- Disassembling the device may cause the battery leakage, explosion, damage or personal injury.
- Never expose the battery to high temperatures, direct heat, or dispose by incineration.
- When disposing of the battery, follow the regulations of the local government. For details, contact your local authorities.

# OVERVIEW

## SUPPLIED ITEMS

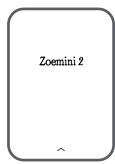

Mini Photo Printer



USB cable



Regulation and  
Warranty  
Information sheet



CANON ZINK®  
Photo Paper  
(10 sheet)

## PRODUCT FEATURES

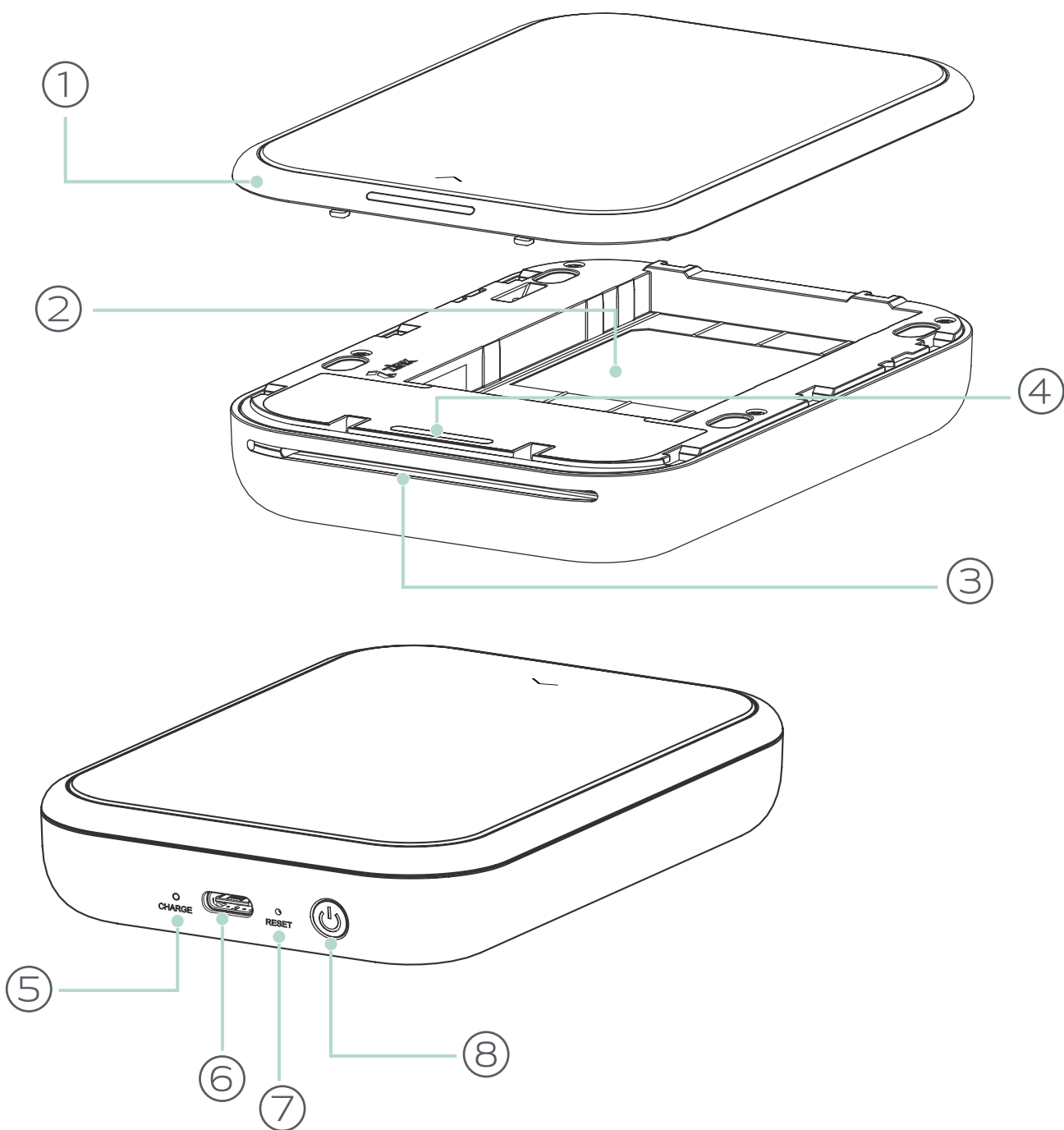

- ① Top cover
- ② Paper tray  
(Visible with top cover open)
- ③ Paper output slot
- ④ Status LED light
- ⑤ Charging LED light
- ⑥ USB port (For charging)
- ⑦ Reset button  
(To reset the device, press with a pin)
- ⑧ Power button

# GETTING STARTED

## A) CHARGING

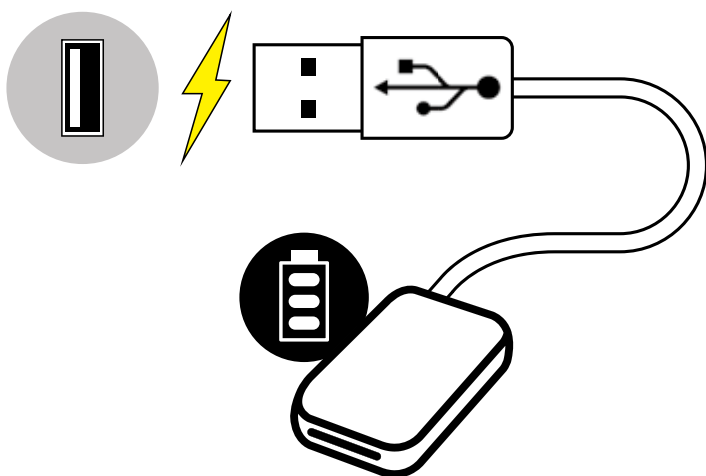

### Charging status LED

Charging	Red	●
Fully Charged	Green	●

The printer uses a built-in battery. Before using the printer, fully charge the battery using the USB cable provided.

- ① Insert the smaller end of the supplied USB cable into the device and the other end into a chargeable USB adapter.
- ② The charging LED light will turn red to indicate charging.
- ③ Once fully charged, the charging LED will turn green.  
– Operating time may vary depending on the battery status, operational status and environment conditions.

**!** **NOTE** Instructions or content are important and must be followed accordingly.



### About the USB Cable

#### Handle the USB cable with care while charging

- Do not place any heavy objects on top of the cable.
- Do not place the USB cable near heat.
- Do not scratch, damage, twist or pull hard on the cable.
- Do not plug or unplug the cable with wet hands.
- Avoid too high/too low temperature or humid conditions.
- Please unplug the USB cable from the power source after charging.
- Please use the supplied USB cable for charging.

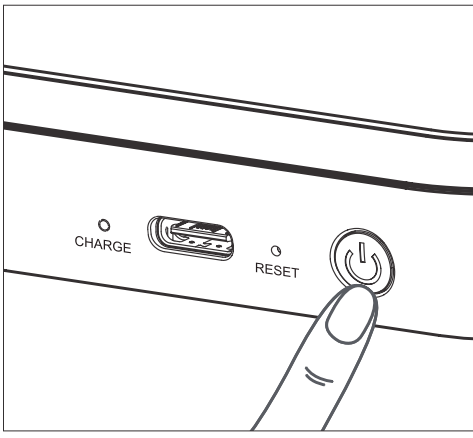
## B) POWER ON/OFF



- ① Press and hold the Power button (  ) Charging LED light will flash 3 times in green to indicate power-on.
- ② When the status LED indicator turns to a white, the device is ready to use.
- ③ Press and hold the Power button (  ) to turn off the device.

### AUTO POWER OFF

- The device will power off automatically when idle for 3 minutes (default).
- The user can change the time (3 minutes/5 minutes/10 minutes) in the app.

## C) LOAD PAPER

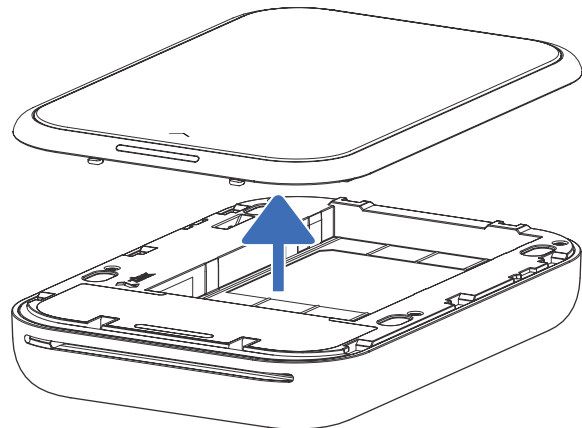
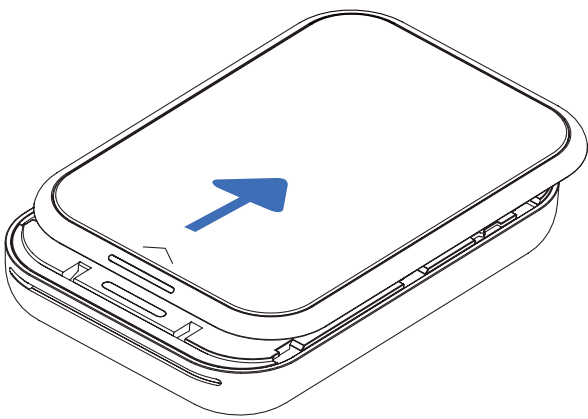

- ① Remove the top cover by sliding it forward in the direction of the arrow.
- ② Open a single pouch of photo paper (10 sheets + blue SMART SHEET®).

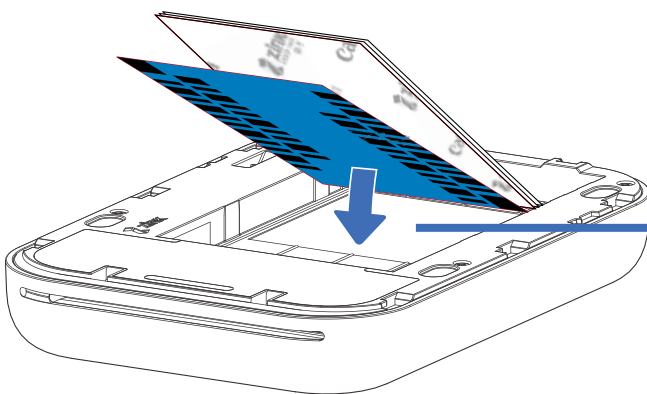

Blue SMART SHEET® on bottom with photo papers on top. All logos facing down.

- ③ Place all 10 photo paper sheets and the one blue SMART SHEET® into the photo paper compartment.
  - Stack the photo paper on top of the blue SMART SHEET®, making sure the bar code and the photo paper logos are facing down.
- ④ Place the top cover back onto the printer. It should click into place when closed properly.
  - The blue SMART SHEET® will be sent through the printer automatically before the first print.





## NOTE

Instructions or content are important and must be followed accordingly.

### MAINTAINING THE DEVICE

- Use and keep the device in the recommended environment of 15° to 32° C and 40-55% relative humidity.
- Keep your device firmware up-to-date. To check if your firmware needs to be upgraded, open the Canon Mini Print app. Go to the Main Menu > Settings > Printers, select your device and tap on Product Info. then tap "Firmware Upgrade".
  - Make sure your mobile device has an internet connection. If you need to upgrade the firmware, your printer must be charged to 50% or higher.
- Make sure you're using the latest Canon Mini Print app version. If your apps don't automatically update, go to app store and check if you need to update.

### WHEN USING PHOTO PAPER













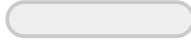
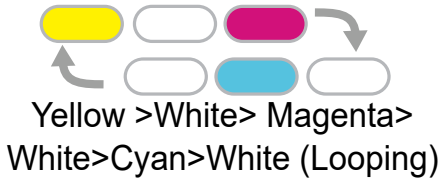
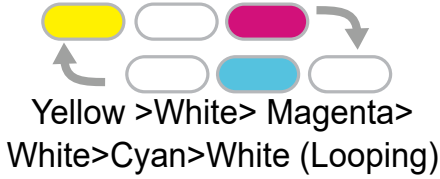

- Only load 10 photo paper sheets and 1 blue SMART SHEET®. Do not load more as it can result in paper jams or printing errors.
- For optimal print results, use photo paper for Canon Zoemini.
  - You may purchase additional photo papers within the Canon Mini Print App by tapping "Buy Paper" in the main menu.
- If there is a paper jam, simply turn the printer OFF and ON to automatically clear the paper jam. Don't try to pull the paper out.
- While the device is printing, don't pull or tug on the photo paper.
- Handle photo paper carefully to avoid damage or bending.
- Keep the photo paper clean when loading. If the photo paper is dirty or damaged, it may result in a paper jam or print error.
- Don't open a new pouch of photo paper until you are ready to load it into your printer
- Don't expose photo paper to direct sunlight or moisture.
- Don't leave your photo paper in an area where the temperature or humidity is out of the suggested conditions indicated on the pouch. It may reduce the quality of the printed photo.

### ABOUT THE BLUE SMART SHEET®

- Each pouch of photo paper contains 10 sheets of photo paper and 1 blue SMART SHEET®.
- Load the blue SMART SHEET® and photo paper from within the same pouch for optimal print quality. Each blue SMART SHEET® is specifically tuned for the pouch of paper it is contained in.
- The blue SMART SHEET® will be sent through the device automatically before the first print to clean the printer and optimize print quality for that specific paper pouch (10 sheets).
- Keep the blue SMART SHEET® and only discard it after you have printed all 10 sheets of photo paper in the pouch. If the print quality is not as expected, you can reuse the blue SMART SHEET® if the paper is still from the same pouch. Simply slide the blue SMART SHEET® with its barcode-side down underneath the remaining photo paper.
- Using a blue SMART SHEET® from a different pouch may result in reduced print quality.

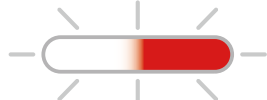

# LED INDICATOR

Status	Mode LED	Status LED
<b>Power On</b>	Press and hold the power button	 >  White      White (Flashing)
<b>Standby</b>	Device is NOT connected with the APP	 White (Flashing)
	Device is connected with the APP	 White
<b>Power Off</b>	Press and hold the power button	 Off
<b>Processing blue SMART SHEET®</b>	When the device is loading blue SMART SHEET®	 Yellow > White > Magenta > White > Cyan > White (Looping)
<b>Printing Photo</b>	When the device is printing a photo	 Yellow > White > Magenta > White > Cyan > White (Looping)
<b>Blue SMART SHEET® Error</b>	When the device detects Canon blue SMART SHEET® is inserted, or other blue SMART SHEET® error	 Blue (Flashing)
<b>Get Ready for Printing</b>	Preparing for printing	 Blue (Glowing)
<b>Paper Jam/ Cover Open</b>	When there is a paper jammed or the printer cover is opened	 Red (Flashing)
<b>No Paper</b>	When print request is initiated and no paper in tray	 Red (Flashing)
<b>Firmware Upgrading</b>	When the device is updating firmware	 White (Glowing)
<b>Low Battery</b>	When battery level is down to 20% - Device is not connected with the APP	 White > Red (Flashing)
	- Device is connected with the APP	 White > Red
<b>Temperature High</b>	When device temperature is too high	 Red (Until temperature returns to normal)
<b>Printer Head Cooling</b>	Checking the printer head temperature and letting it cool down before printing	 Cyan (Glowing)
<b>Temperature Low</b>	When device temperature is too low	 Cyan (Until temperature returns to normal)

# SPECIFICATIONS

<b>Power Source</b>	Internal rechargeable battery 500 mAh Li-Polymer 7.4 V
<b>Charging Speed</b>	Approximately 45 minutes (Full Charge)
<b>Dimensions</b>	120 mm (L) x 84 mm (W) x 21.5 mm (H)
<b>Weight</b>	177 g
<b>Connectivity</b>	Bluetooth® 5.0
<b>Compatible OS</b>	iOS 12.0 or above & Android 6.0 or above
<b>Print Technology</b>	ZINK®
<b>Print Resolution</b>	313 x 512 dpi (dots per inch)
<b>Borderless Printing</b>	Yes
<b>Compatible Paper</b>	Canon ZINK® Photo Paper: ZP-2030-20 (20 sheets) ZP-2030-50 (50 sheets) ZP-2030-2C-20 (20 sheets) 2" x 3" / Peel-and-stick back
<b>Paper Capacity</b>	Up to 10 sheets of ZINK® photo paper + 1 blue SMART SHEET®
<b>Memory</b>	512Mb
<b>Environmental Parameters</b>	<ul style="list-style-type: none"><li>• Recommended Printer Operating, Charging, and Storage Temperature: 15° to 32° C</li><li>• Recommended Printer Operating, Charging, and Storage Humidity: 40-55% RH</li><li>• Operating Temperature: 5° to 40°C</li><li>• Operating Humidity: &lt;70% RH</li></ul>
<b>Automatic Power-off</b>	3 minutes / 5 minutes / 10 minutes (selectable in-app) (The Printer will not turn off automatically if the application is being used.)
<b>Power Adapter</b>	Output power : 5V $\Rightarrow$ 2.25A or above

\* All specifications are subject to change without notice

\* The Zoemini 2 Mini Photo Printer is designed to be charged with a USB Charging Adaptor. If it is charged using a laptop USB port, there may not be sufficient electrical power to charge the Zoemini 2 Mini Photo Printer.

# INSTALLING THE APP

## OPTION ① SEARCH FOR "CANON MINI PRINT" IN APP STORES

For Android™ - from Google Play™

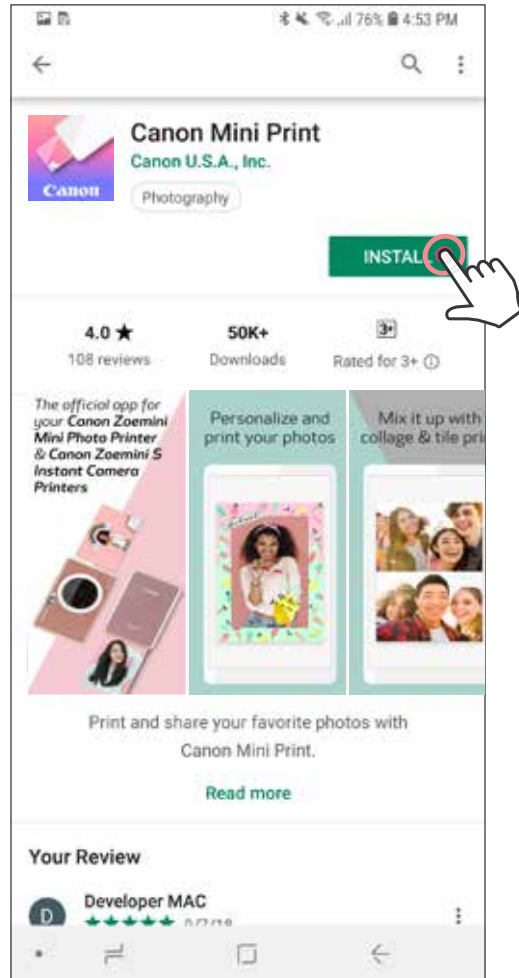
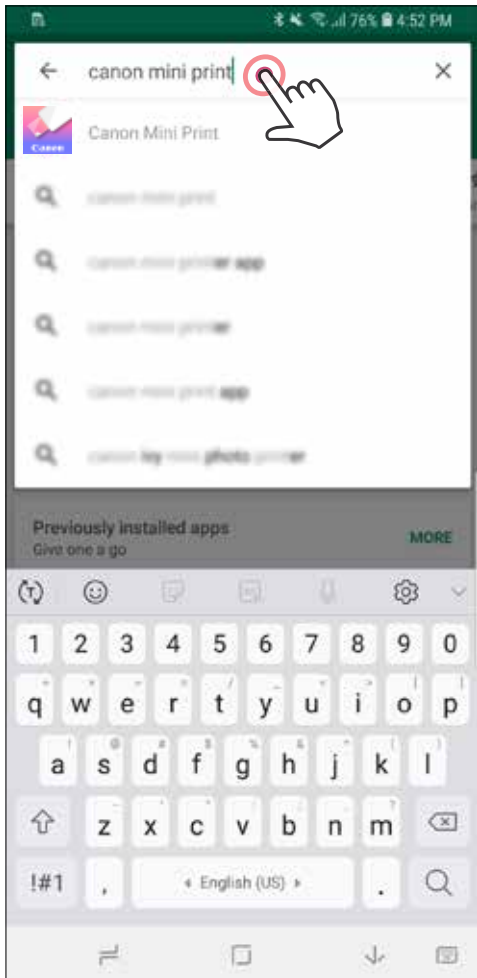

For iOS® - from the App Store®

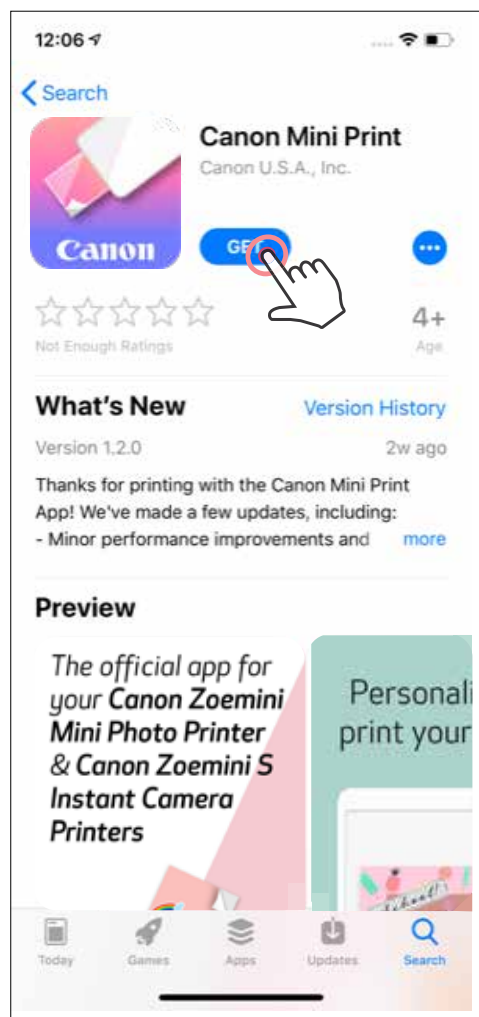
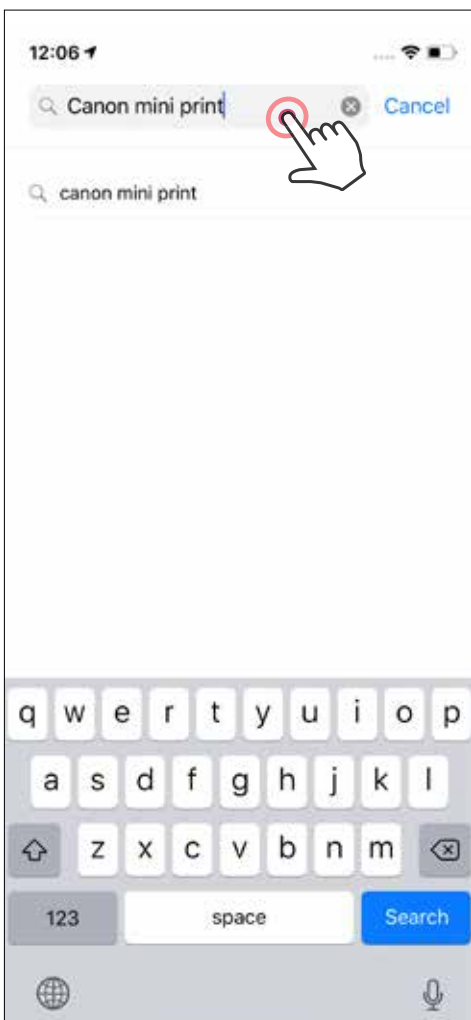

OPTION ②  
ON THE QUICK START GUIDE -  
SCAN THE QR CODE TO DOWNLOAD THE  
CANON MINI PRINT APPLICATION

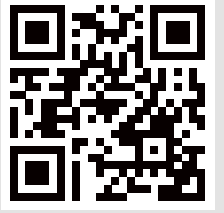

For Android

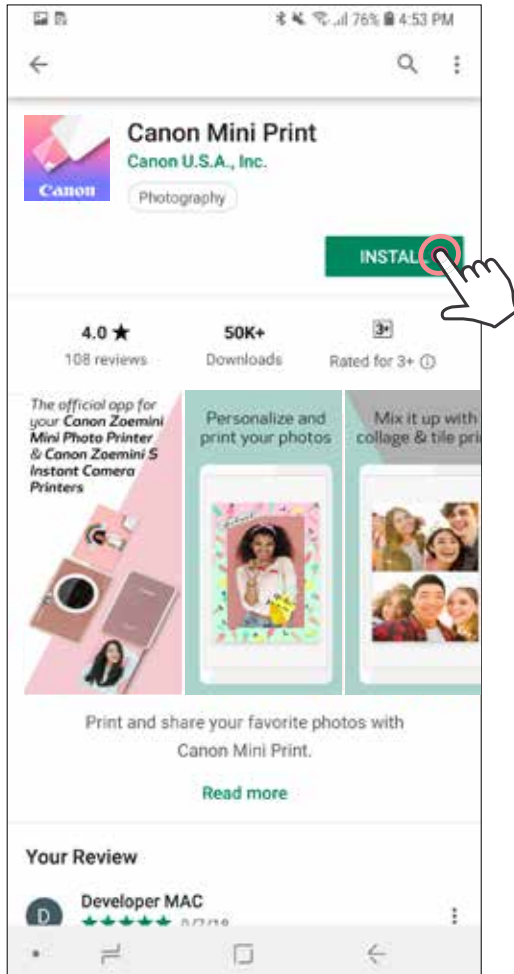

For iOS

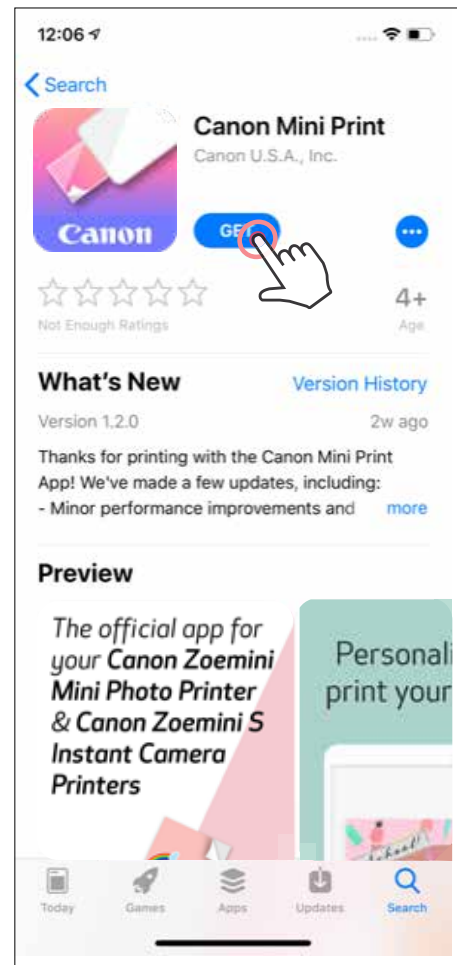

OPTION ③  
GO TO [HTTPS://APP.CANONMINIPRINT.COM/](https://app.canonminiprint.com/) WITH  
YOUR DEVICE INTERNET BROWSER

# PAIRING A MOBILE DEVICE & MINI PHOTO PRINTER

## Android and iOS Pairing

- ① Turn on the printer by pressing and holding the Power button until the status LED light turns on.  
Open mobile device "Settings" to enable Bluetooth and pair it with the printer.
- ② **Pair** - Tap on the icon in the top right corner and choose your printer. The icon will change to indicate battery level after connection.

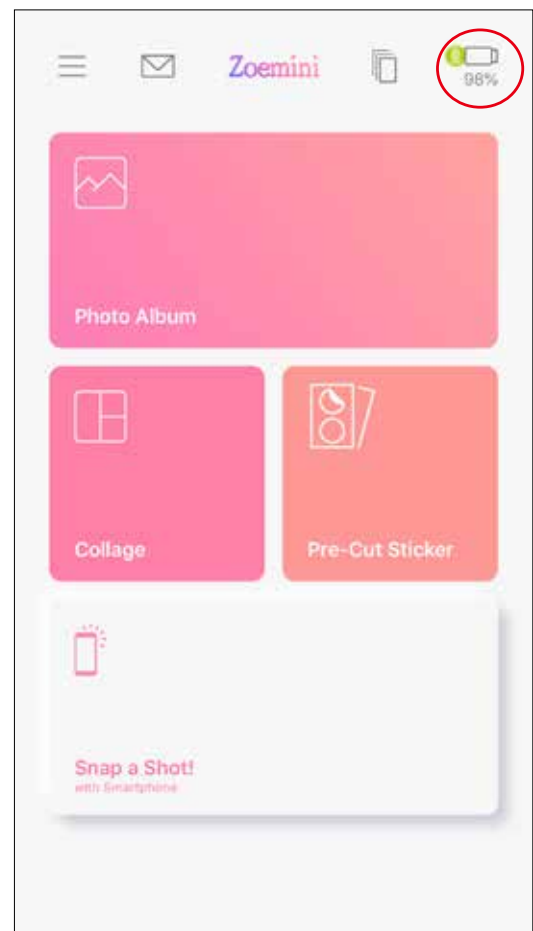
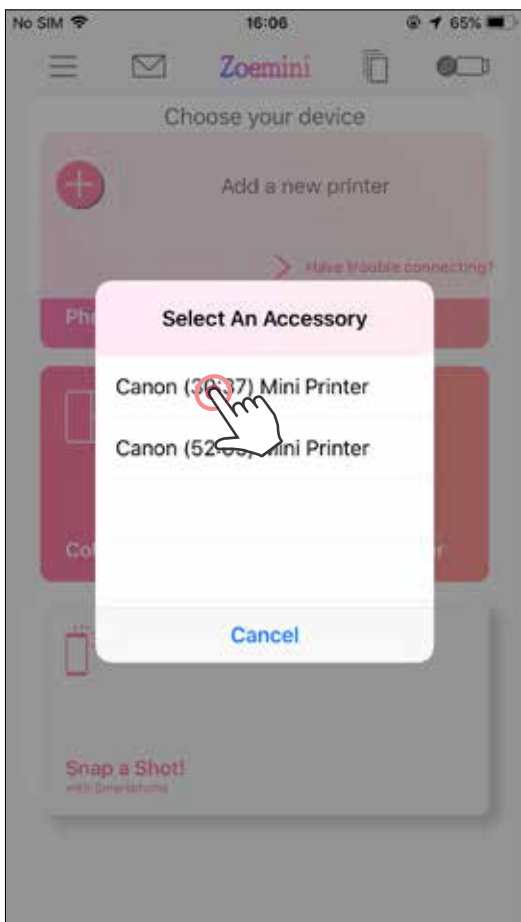
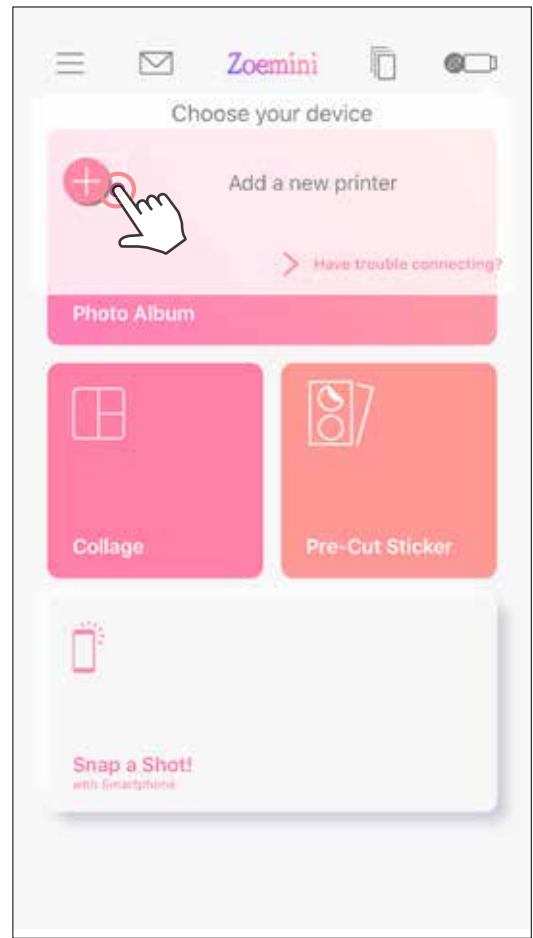
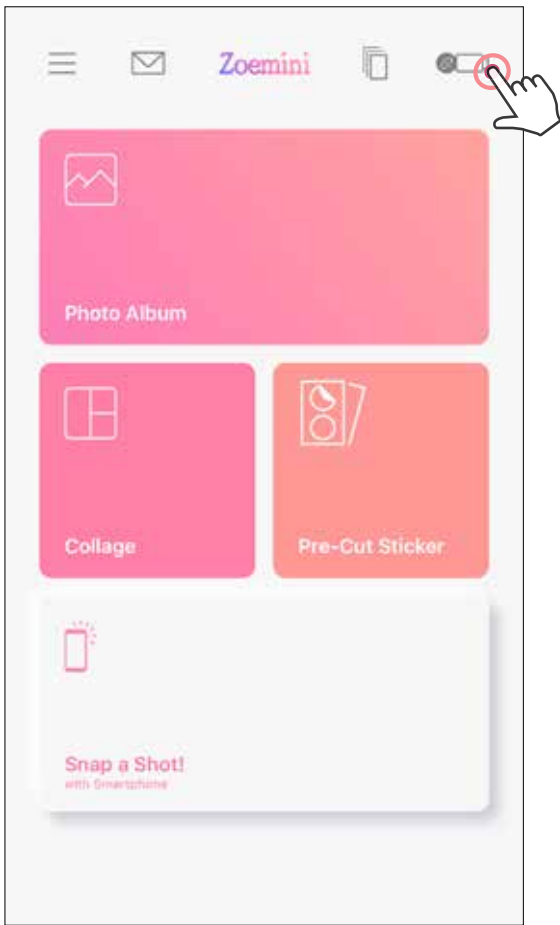

- ③ **Reconnect Printer** - The printer will automatically reconnect to the app once paired already. If the printer has not connected to the app, tap on the icon in the top right corner and choose your printer from the list.

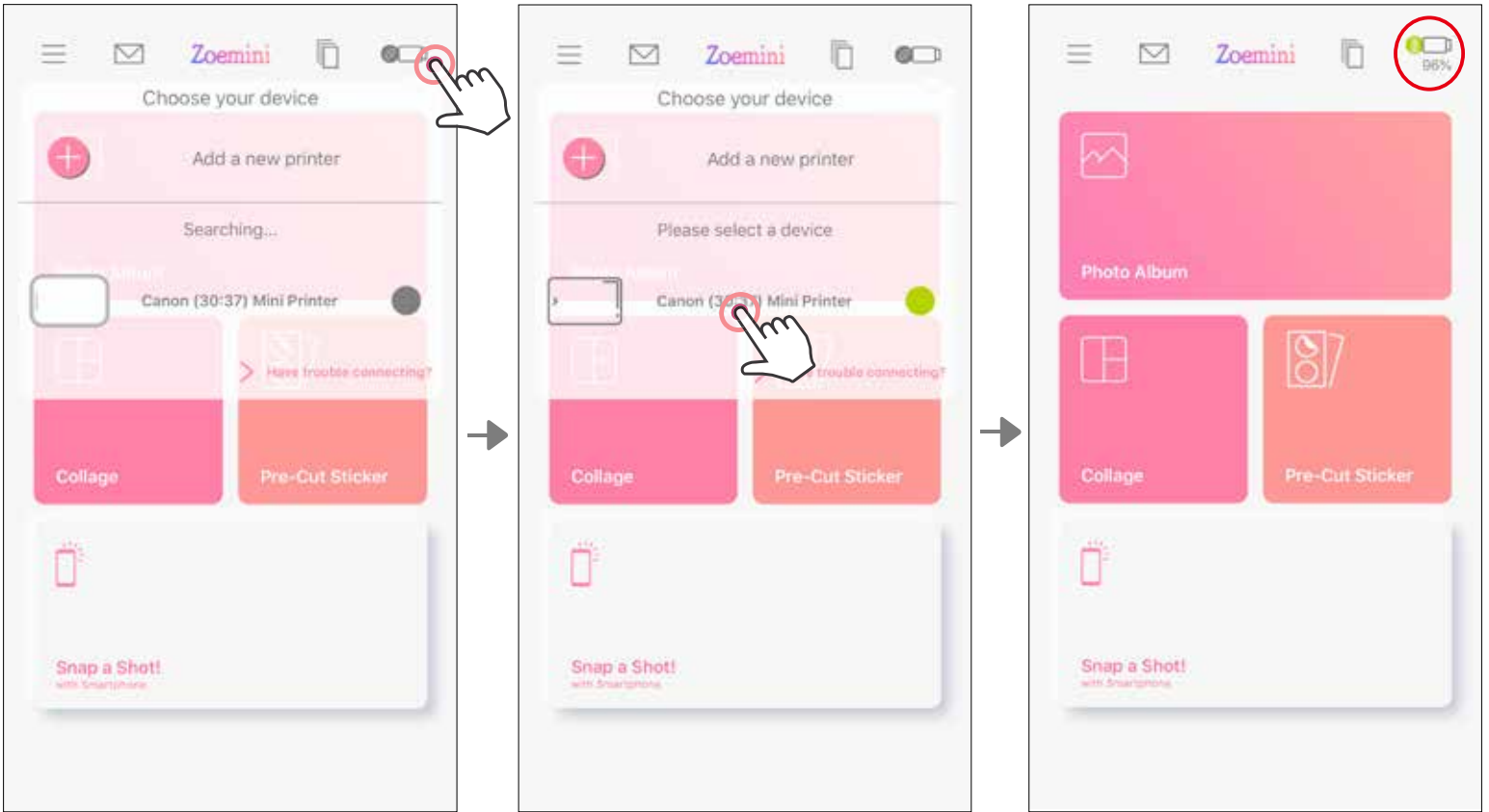

## NOTE

### Printer Status Icon (shown in App)



Printer not connected



Printer connected  
(Battery status shown)

### About Pairing

- One printer can be paired with only one iOS/Android device.
- One iOS/Android device can be connected to multiple printers.  
To pair an additional printer, go to the home page and tap on the icon in the top right and press " + " to choose the printer.
- Search for and pair a printer named "Canon (xx:xx) Mini Printer".  
Match the last 4 digits of the MAC number (xx:xx) on the label inside the printer.
- Bluetooth searching and transferring may fail depending on the environment.  
Check the Bluetooth setting on your mobile device and try again.

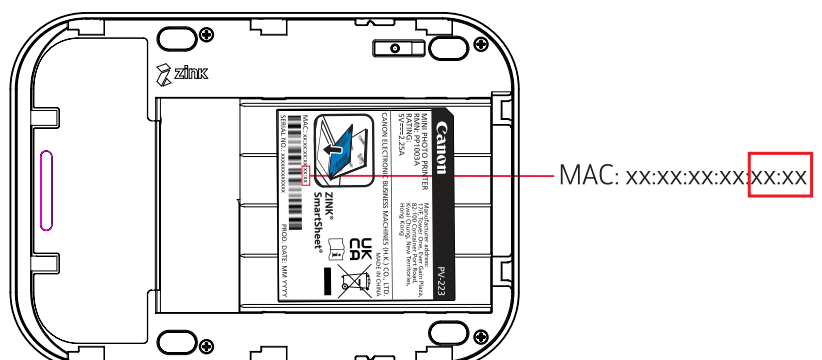
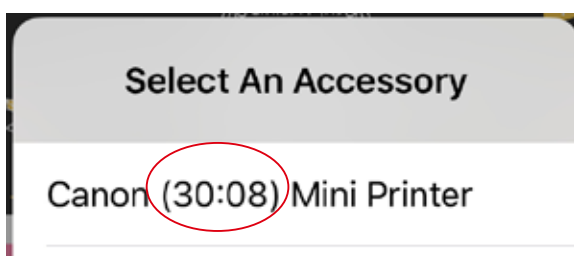



# USER INTERFACE

## HOME SCREEN

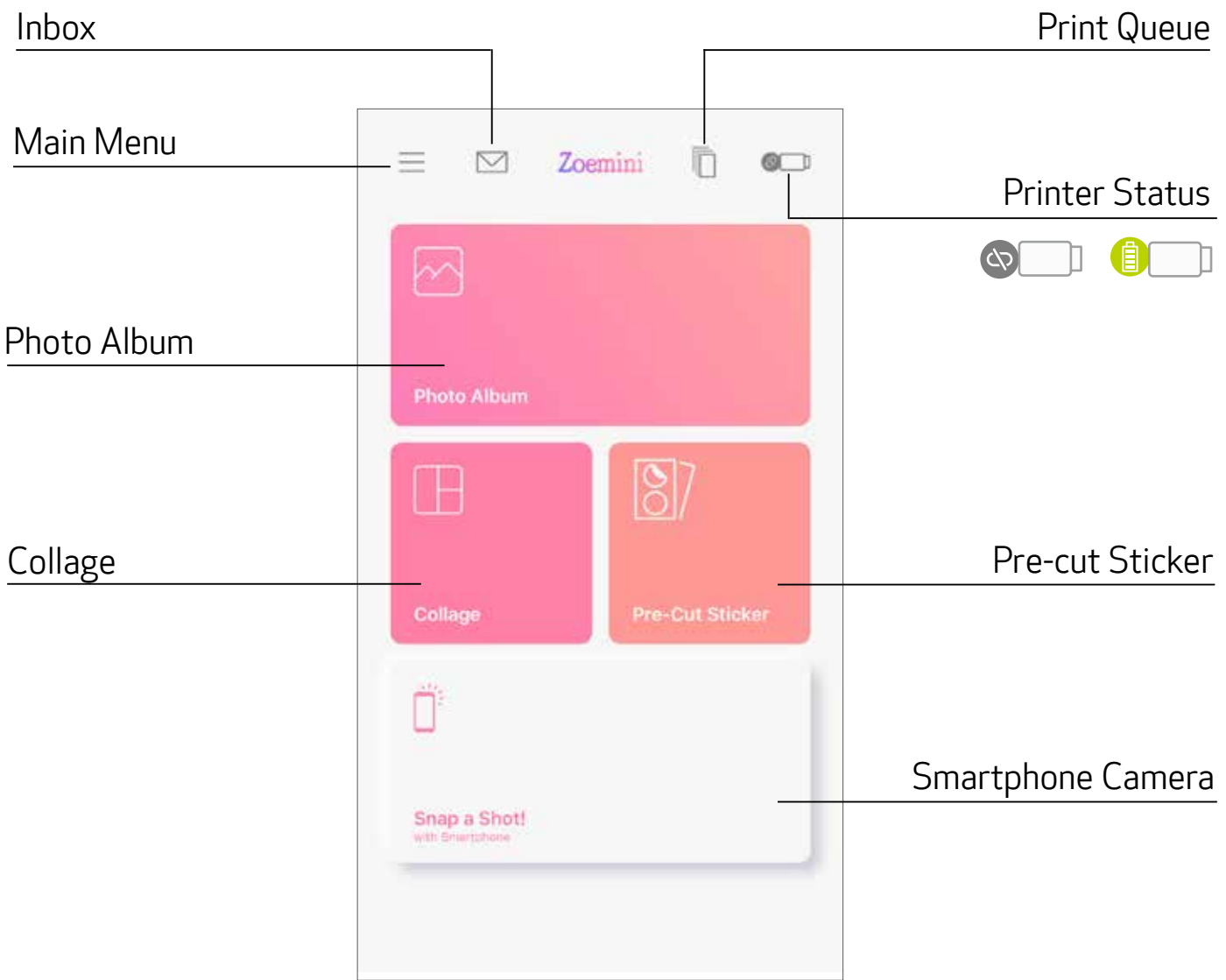

## MAIN MENU

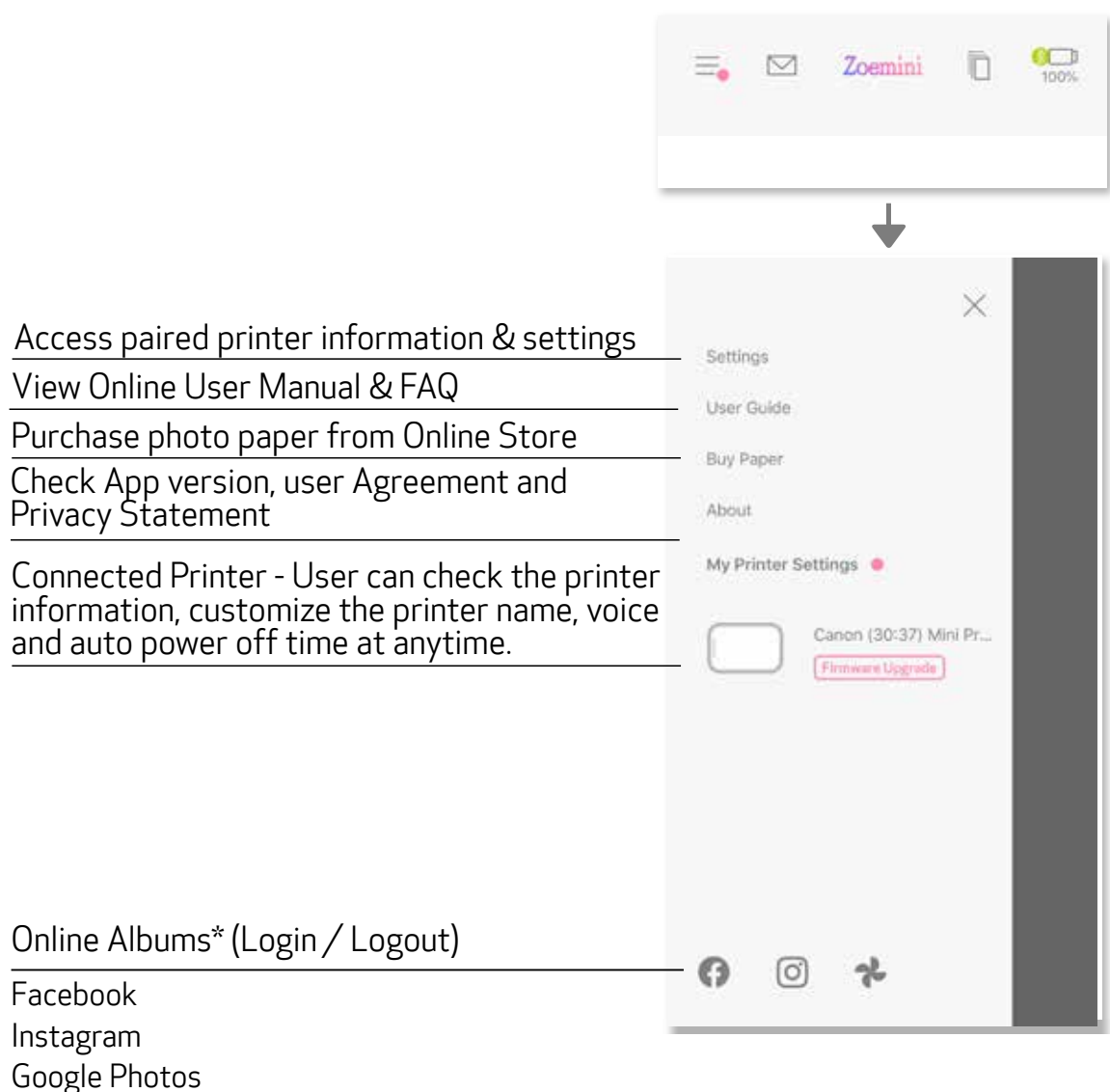

App experience, features, and available Online Albums may vary depending on your device and region.

\* Internet Connection Required. Requires an active social media or Cloud account(s) to use.



# PRINTER SETTINGS

When the printer is connected with a mobile device, the user can customize the printer name and auto power off time.

Tap , select your device to customize the printer name and auto power off time through the App.

## RENAME

The user can customize the printer name as desired.

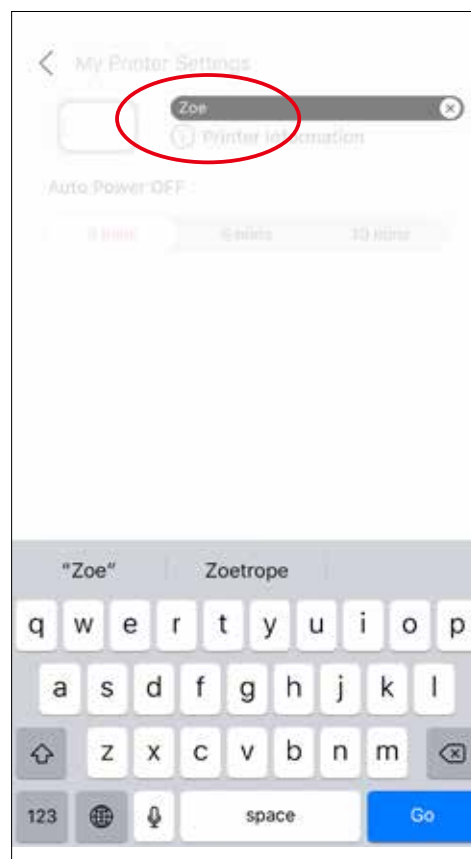
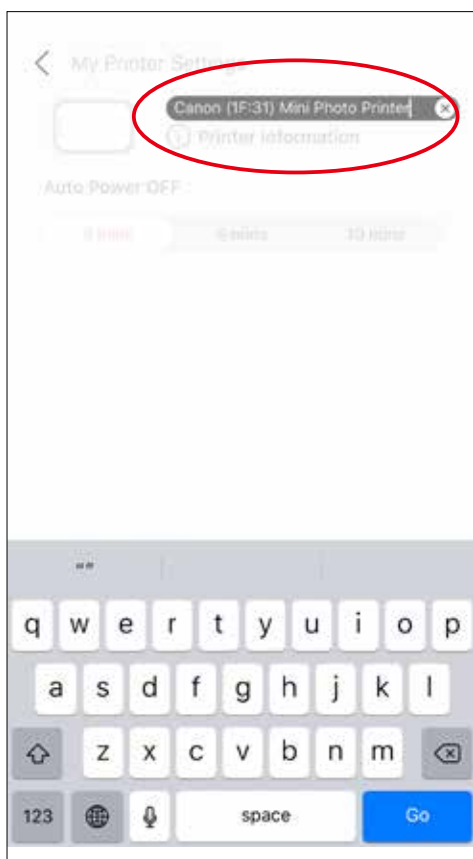
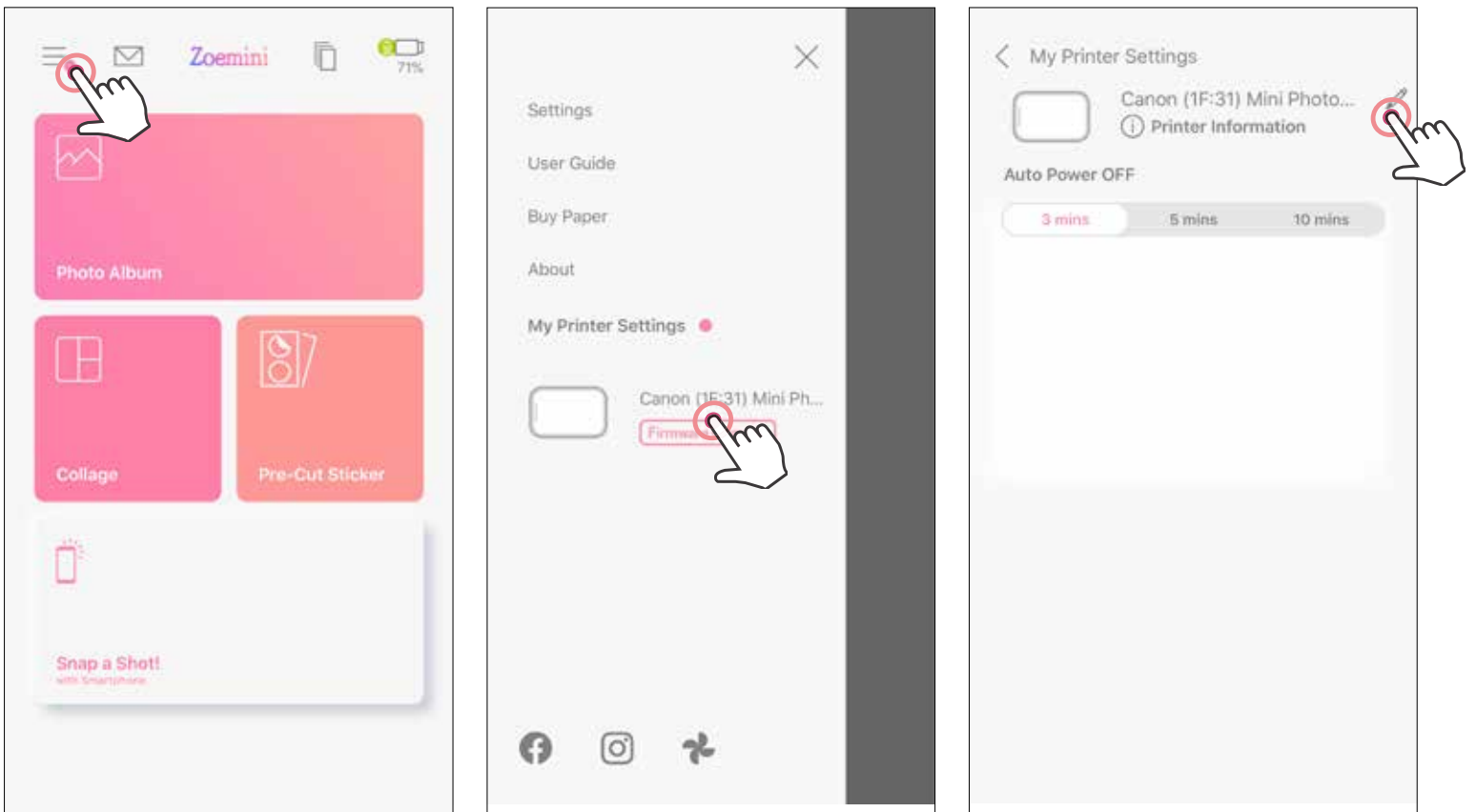

## AUTO POWER OFF

Tap to change the auto power off time.

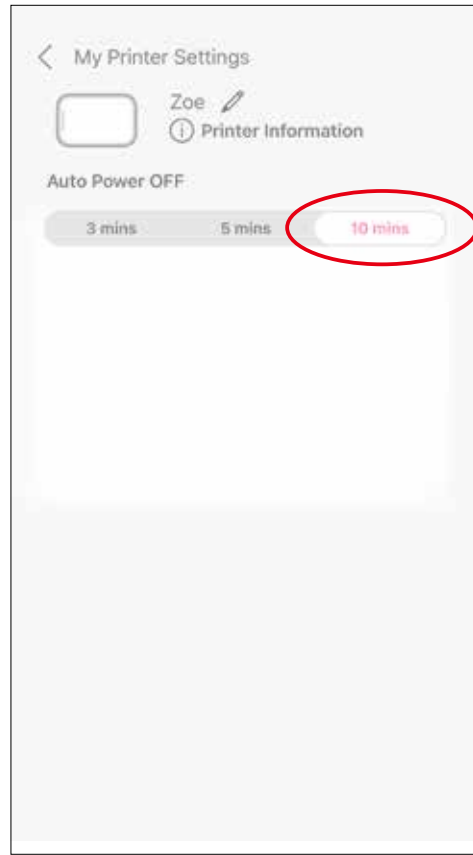
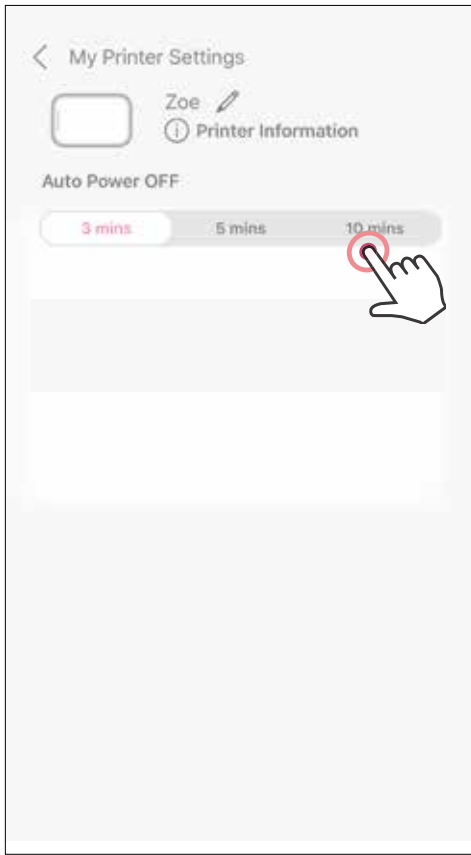



If the device is not functioning properly, please contact the dealer you purchased this product from or Canon Service & Support at [www.canon-europe.com/support](http://www.canon-europe.com/support)

SMART SHEET, the ZINK Technology and ZINK Trademarks are owned by ZINK Holdings LLC. Used under license. Apple, the Apple logo, iPad, iPad Air, iPad Pro, and iPhone are trademarks of Apple Inc., registered in the United States and other countries. App Store is a service mark of Apple Inc. iOS is a trademark or registered trademark of Cisco in the United States and other countries and is used under license. Android and Google Play are trademarks of Google LLC. Bluetooth is a registered trademark of Bluetooth SIG. Wi-Fi is a registered trademark of the Wi-Fi Alliance. All other third-party product names, brand names and logos are trademarks of their respective owners.